

M12 female receptacle A-cod. front mount incl. nut

wires PP 5x0,34 0,2m

Flange female
M12, 5-pole
Front mounting
with multi-strand wire**Illustration**

Female

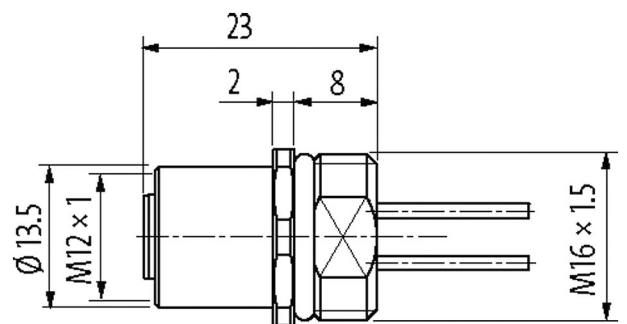
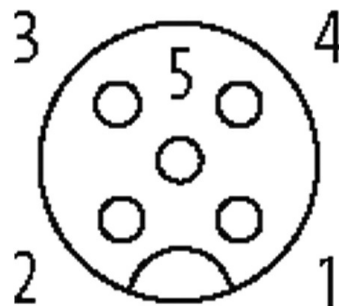

Product may differ from Image

Approvals

**Form**

Form 13562

Cables

Cable number	972
No./diameter of wires	5 × 0.34 mm ²
Wire isolation	PUR (br, wh, bl, bk, gr)
Outer Ø	1.3 mm ±5%
Temperature range (fixed)	-40...+90 °C
Temperature range (mobile)	-25...+90 °C
Material (wire)	Cu wire, tin plated
AWG	max. 58 Ω/km (20 °C)
Nominal voltage	300 V AC
Test voltage	1500 V AC
Bend radius (fixed)	5 × outer Ø

Technical Data

Operating voltage	max. 125 V AC/DC
Rated surge voltage	1.5 kV
Operating current per contact	max. 4 A
No. of poles	5
Material group	IEC 60664-1, category I
Coding	A-coded
LED display	no
Locking of ports	Screw thread (M12×1 mm) recommended torque 0.6 Nm, self-securing
Compression gland	M12 (SW14)
Protection	IP67 inserted and tightened (EN 60529)
Protection NEMA	3, 4, 6P (UL 50E)
Material	Zinc die casting, brass-plated
Locking material	Zinc die casting, matte nickel plated
suitable for corrugated tube (internal Ø)	without

General data

Standards	DIN EN 61076-2-101 (M12)
Mounting method	inserted, tightened
Material (contact)	Copper alloy
Material (contact surface)	Au
Material (gasket)	FKM
Pollution Degree	3
Temperature range	-25...+85 °C, depending on cable quality

Commercial data

country of origin	DE
customs tariff number	85444290
EAN	4048879494113
eClass	27279220
Packaging unit	1

Sketch

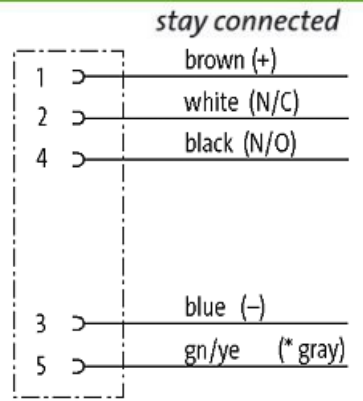

(* for cable type 902, 972)

Product may differ from Image